

1 HEAD DETAIL
325

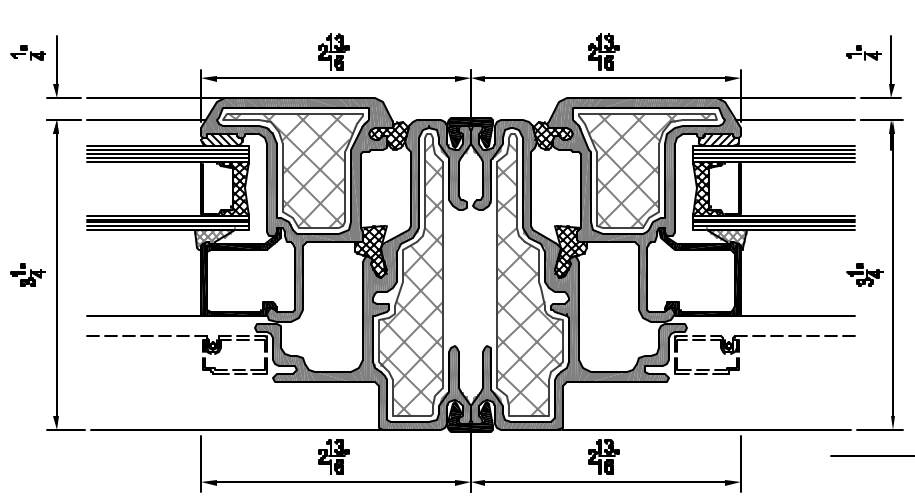

4 INTERMEDIATE DETAIL
325

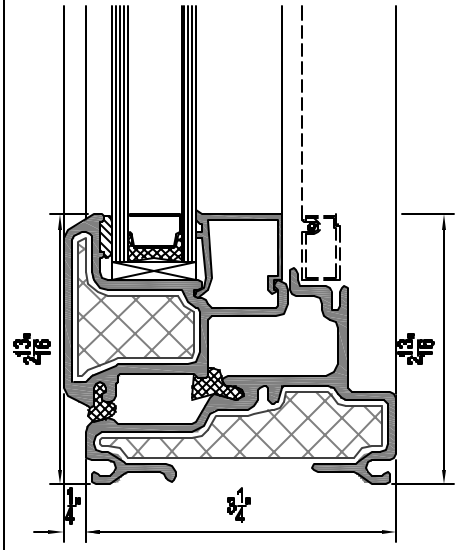

2 SILL DETAIL
325

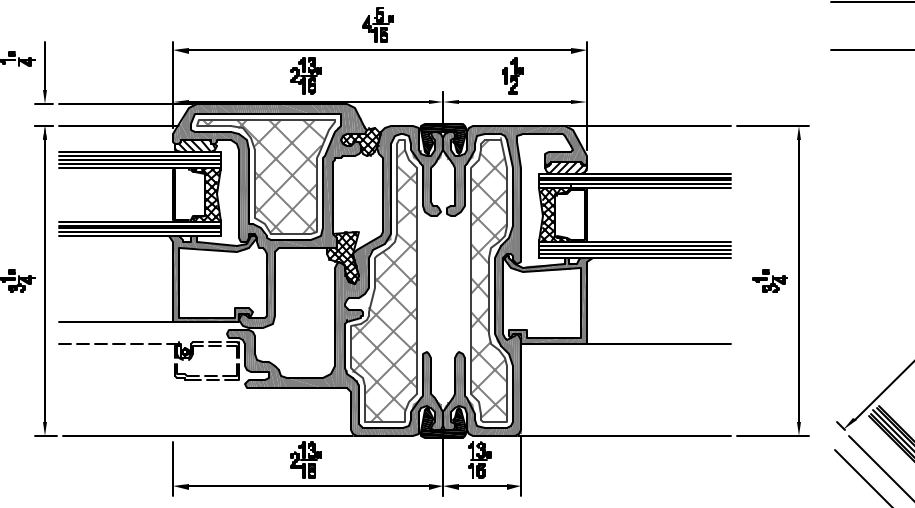

5 INTERMEDIATE DETAIL
325

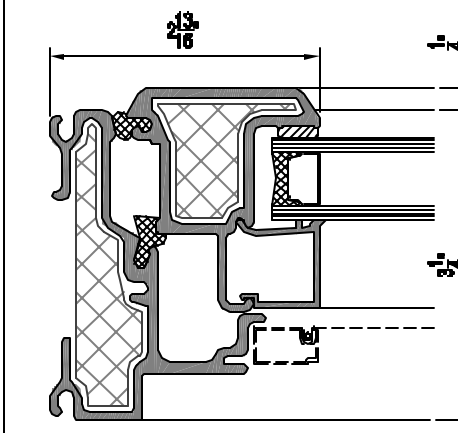

3 JAMB DETAIL
325

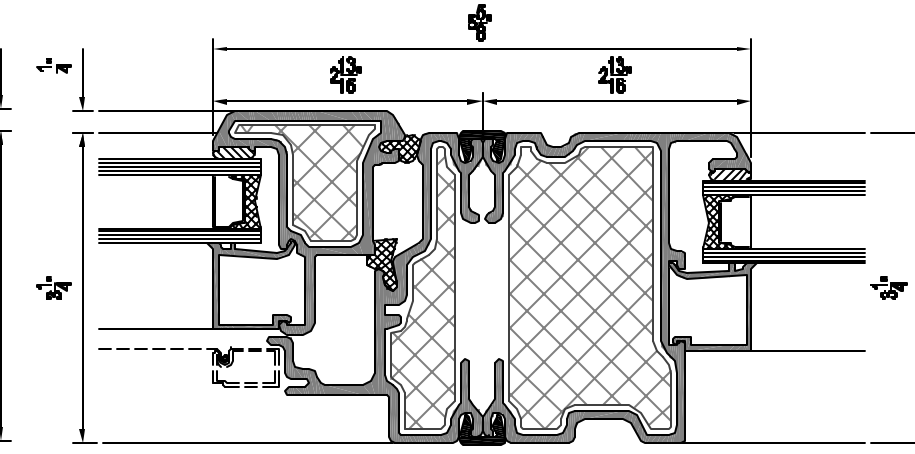

6 INTERMEDIATE DETAIL
325

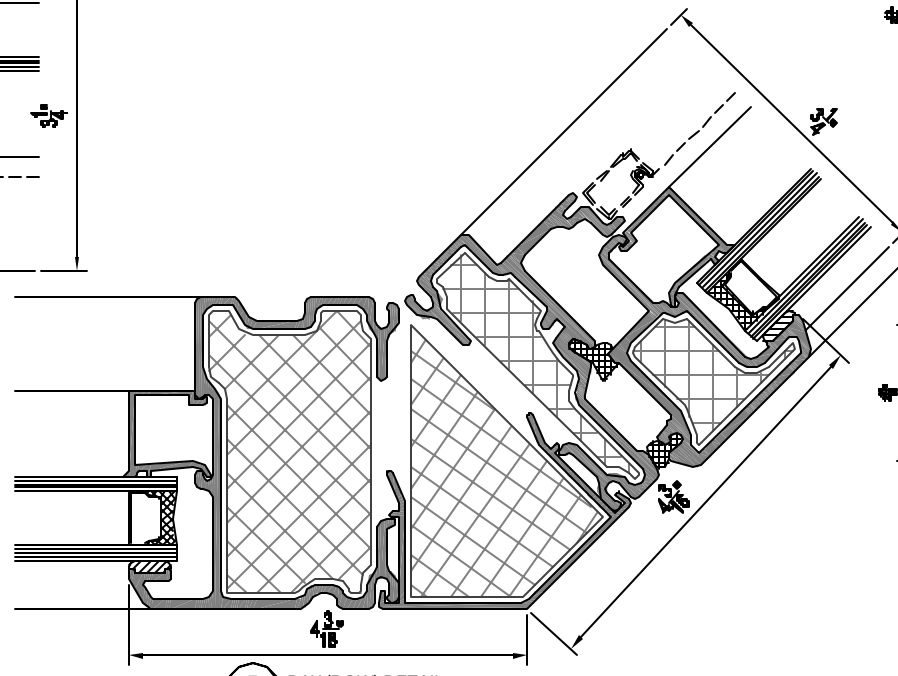

7 BAY (BOW) DETAIL
325

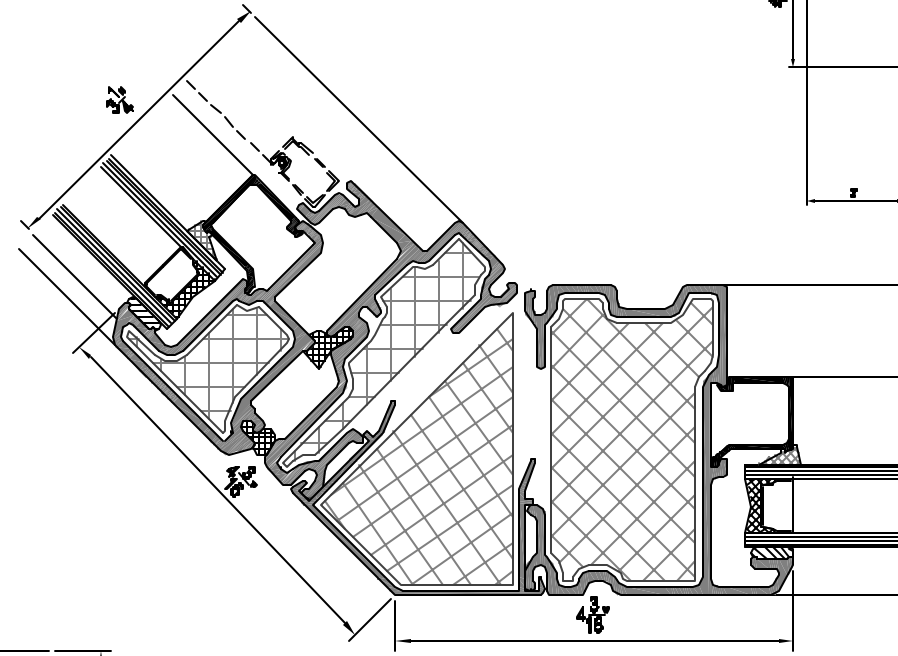

8 BAY (BOW) DETAIL
325

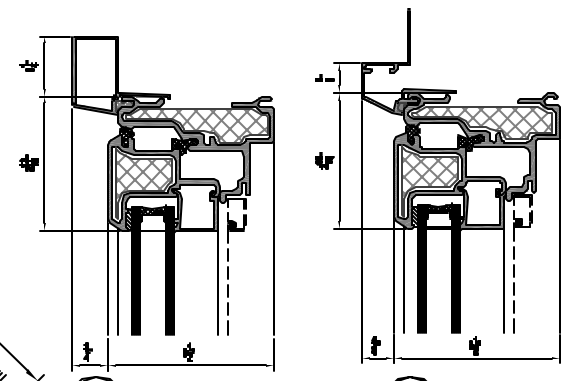

A #110
325

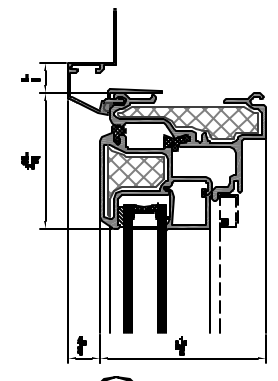

B #112
325

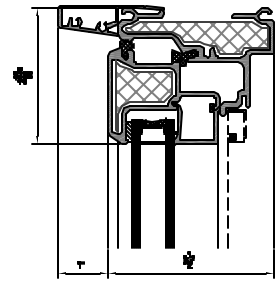

C #115 1-1/4
325

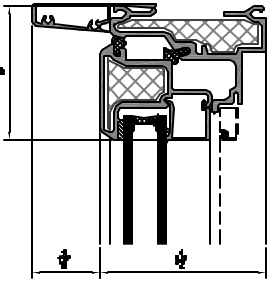

D #115 1-5/8
325

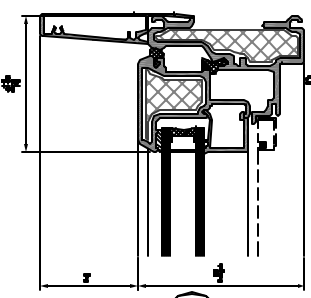

E #115 2-1/4
325

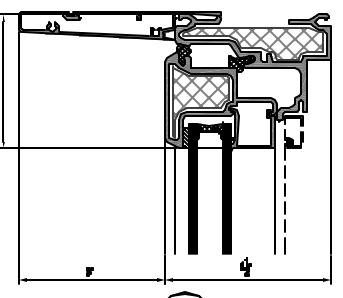

F #115 3-1/4
325

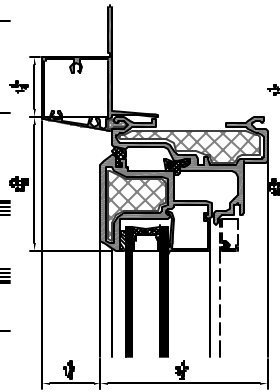

G #128
325

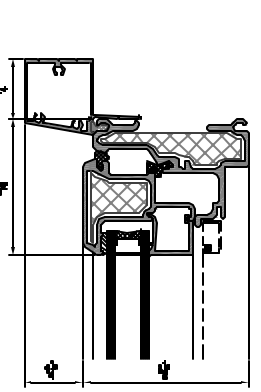

H #128A
325

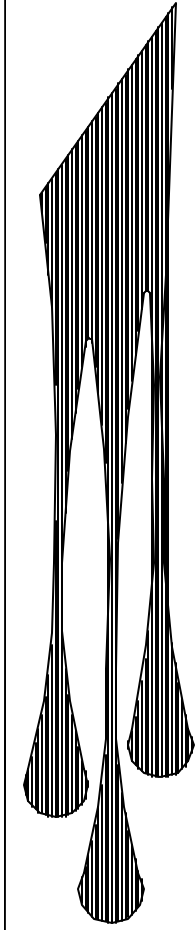
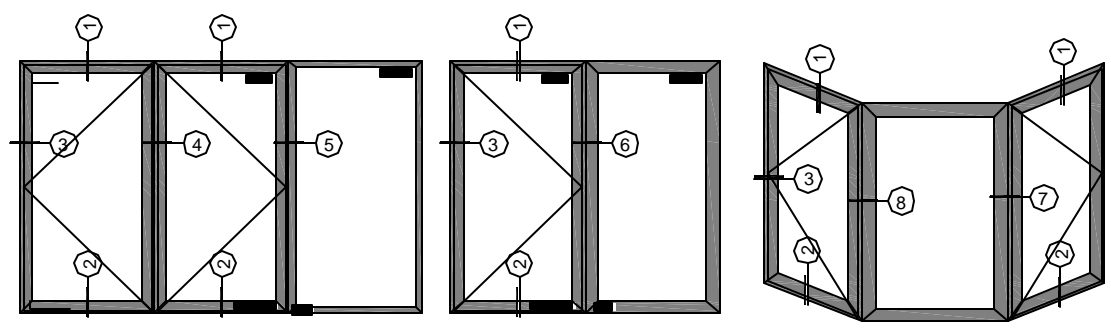

INLINE
FIBERGLASS LTD.

30 CONSTELLATION COURT, ETOBICOKE, ONTARIO.

REVISIONS		
No.	Description	DATE

TITLE:
**SERIES 900
WINDOWS**

DESIGN: F.B.	DWG NO:
DATE: APR 1, 2013	325
SCALE: N.T.S.	
CHECK: L.B.	
REV: 0	